Introduction

Welcome

Congratulations on your purchase of the BCT-12 Highway Information System & Pre-programmed Warning Scanner! State-of-the-art engineering and advanced electronics provide you with a pre-programmed information radio designed for easy operation and dependability.

With the BCT-12 Scanning Radio, you can listen to hundreds of highway patrol, local police, sheriff's department, department of transportation, and news media frequencies as well as NOAA weather channels.

The frequencies in your BCT-12 have been uniquely selected on a State-by-State basis to provide you with the highest level of scanning quality. Plus, new built-in technology sounds an alarm when a priority channel is detected!

Best of all, you don't have to program any frequencies. Just set the BCT-12 for your state, and the scanner will do the rest. Please read this Operating Guide thoroughly before attempting to operate the unit.

Features

- Priority Alert
- Local Police Coverage
- Highway Patrol Coverage
- 9-Level Strength Meter
- Weather Alert
- Highway Patrol Detection
- Windshield Mountable
- Instant Weather
- Built-in Speaker
- DOT Coverage
- News Media Coverage
- Pre-programmed Scanner Covers All 50 States Plus Canada

Visit our Internet site at <http://www.uniden.com>.

Terms and Definitions

- Frequency** Radio signals are sent as waves through the air. These waves move up and down. A frequency is the number of times in a certain time period, usually a second, that these waves move all the way up and all the way down and back to all the way up. For example: 123.450 kHz means that the waves are moving all the way up and all the way down and back all the way up again 123,450 times each second.
- Mobile Extender** Most Highway patrol vehicles on the road today are equipped with a secondary radio system known as a “mobile extender” or “vehicle repeater.” Whenever the dispatcher transmits to any vehicle in the district, every “mobile extender” in every car withing the district is activated.
- Priority Alert** Using a constant PRIORITY check of specific frequencies in each state, the BCT-12 recognizes and alerts you to transmissions from “mobile extender” radios as well as from car-to-car, aircraft-to-aircraft and other special-purpose frequencies. You receive an audible (beep tone) and visual (flash of warning light) alert whenever you are within an approximate three mile radius of many Highway Patrol/State Police units.
- Scanning** Scanning is the process by which your scanning radio checks each frequency for the presence of a signal, and when it finds a frequency with a signal, for example someone talking on it, it stops, allowing you to listen to the signal.
- Weather Alert** Lets your scanner function as a severe weather warning radio. With Weather Alert turned on, when the NOAA issues a severeweather warning radio. With Weather Alert turned on, when the NOAA issues a severe weather warning, the BCT-12 sounds an alert tone and youl will hear the emergency weather broadcast.

Unpacking

Carefully remove all items from the box. If there is any visible damage, do not operate the equipment. Notify your dealer or shipping carrier immediately.

For information or instructions on any problem that you may have, call the Uniden Customer Service Center at:

(800) 297-1023 Monday through Friday,
8:00 a.m. to 5:00 p.m. Central.

Included with Your BCT-12 Scanner

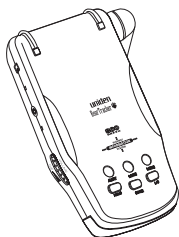

The BCT-12 Highway Information System

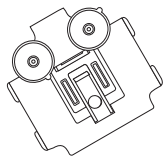

Windshield Mounting Bracket and Hardware

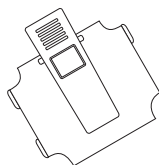

Visor Clip Mounting Bracket

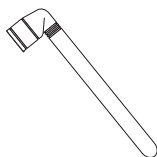

BCT-12 Antenna

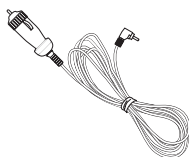

Cigarette Adapter Power Cord



BCT-12 Operating Guide



Window Mount Antenna



Other Printed Material

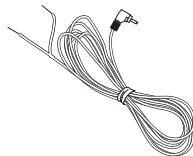

Straight Power Cord

If any of these items are missing, please contact your place of purchase.

Installation

The BCT-12 uses a highly sensitive antenna to receive radio signals. Its sensitivity and range depend on the method of installation and the direction of the antenna in relation to the signal source. Before you decide where to put your scanner, please keep in mind one important factor:

For safety, do not mount the BCT-12 in a location where it will obstruct your driving vision.

Helpful Tips

The antenna is located on the side of the unit. It should not be obstructed and should be pointed as close to straight up or down for best operation.

- Do not mount the unit in front of the heater or defroster vents.
- Do not leave the unit in direct sunlight or in the glove compartment of a closed car for long periods of time. Also, removing the unit from the windshield makes you less susceptible to break-in and theft.
- Be sure the BCT-12 is mounted free of obstructions from the rear view mirror, sun visors, or the ceiling of the automobile.

Optional Antennas

Your BCT-12 was designed for the easiest installation possible. Uniden has packaged an additional Window Mount antenna with your BCT-12 that will provide better performance on VHF frequencies. For the best reception possible in every state, you might consider a mobile scanner antenna which mounts magnetically to your car or truck.

For more information on these and other options available for your BearTracker, please ask your local Uniden dealer or call 1-800-248-5441.

Installing the Antenna

BCT-12 Antenna

1. Pinch the sides of the antenna and attach it to the BCT-12.

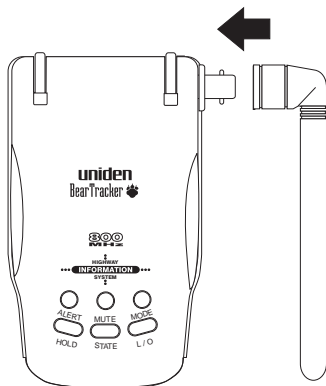

Window Mount Antenna

1. Mount the antenna on the inside of the windshield at the far right-hand (passenger) side.

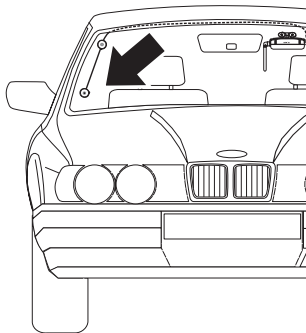

Caution: Be sure the antenna does not obstruct the driver's vision in any way.

2. Route the antenna cable so it is out of the way and does not obscure your view.

Caution: Be sure the cable is out of the way of anyone getting in or out of the car.

3. Plug the cable's BNC connector into the BCT-12.

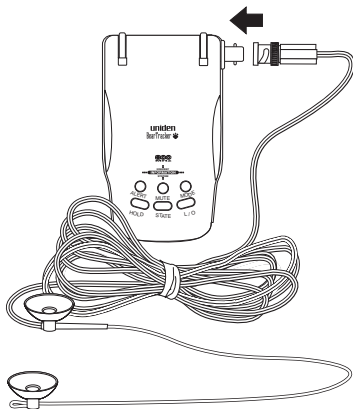

Mounting the BCT-12

Visor Mounting

1. Snap the visor clip onto the BCT-12.

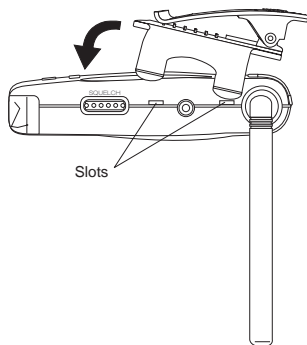

Note: Make sure that the bracket tabs fit securely in the slots.

2. Slide the clip over the front of the visor.

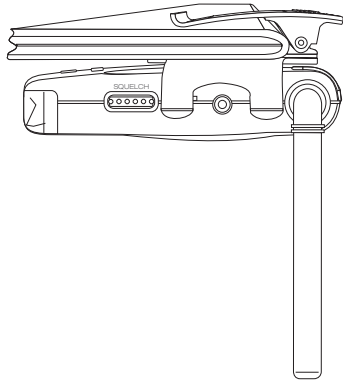

3. Adjust the angle of the antenna as close to straight up or down as possible.

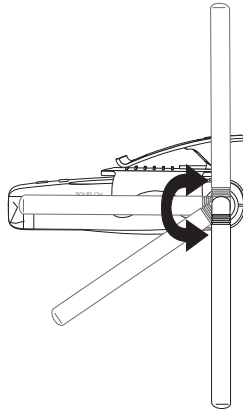

Note: You can remove and replace the BCT-12 by sliding both the unit and the visor mount off and on the visor.

Windshield Mounting

1. Find a good position for the BCT-12 on your windshield. Refer to the Helpful Tips on page 5 for some guidelines on mounting positions.

2. Put the metal mounting bracket with the suction cups on the windshield to adjust it for best position.

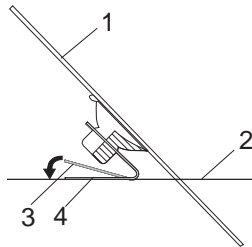

1. Windshield
2. Road Surface
3. Metal Mounting Bracket
4. Metal Mounting Bracket parallel to road

3. If necessary, adjust the metal mounting bracket so that when you slide the BCT-12 onto it, it is parallel to the road surface and fits flush against the windshield. Your BCT-12 should look like one of the examples at the right once it is installed.

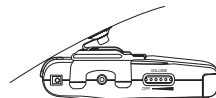

Caution: Do Not adjust the metal mounting bracket with the BCT-12 attached. Doing so can cause damage to the bracket and the unit.

4. Snap the windshield mounting clip onto the BCT-12.

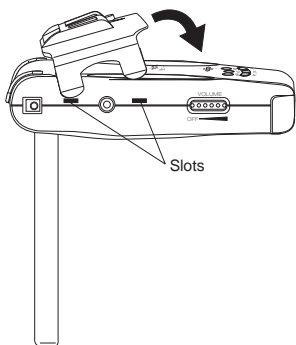

5. Slide the plastic windshield mounting clip into the metal mounting bracket.

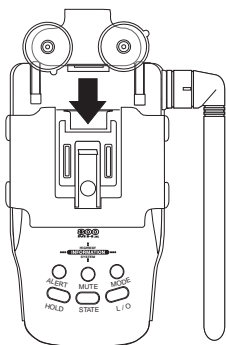

The mounting clip locks into the plastic portion at three different positions. These positions can be used for vehicles with different vertical angles of their windshields. The back position can be used for vehicles with windshields that are slanted back.

6. Place the bracket and the BCT-12 in the proper location on the windshield of your vehicle and press the suction cups firmly against the windshield. If the BCT-12 does not fit flush against the windshield, try a different position on the metal mounting bracket.

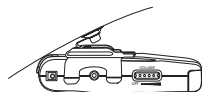

7. Adjust the angle of the antenna as close to straight up or down as possible.

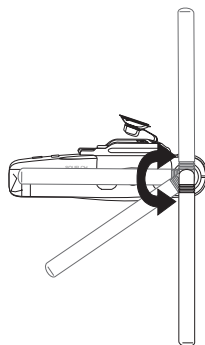

Connecting the Power

Direct Connection

WARNING: *The BCT-12 is designed to operate only with 12V DC, negative ground power systems. Operation of the unit on other voltages or polarities will cause damage to the unit and may create a fire hazard.*

The straight power cord provided with the unit has bare wires at one end and a small connector at the other end.

1. Connect the positive wire to a 12V DC source in your vehicle's fuse box.
2. Connect the other wire to ground.

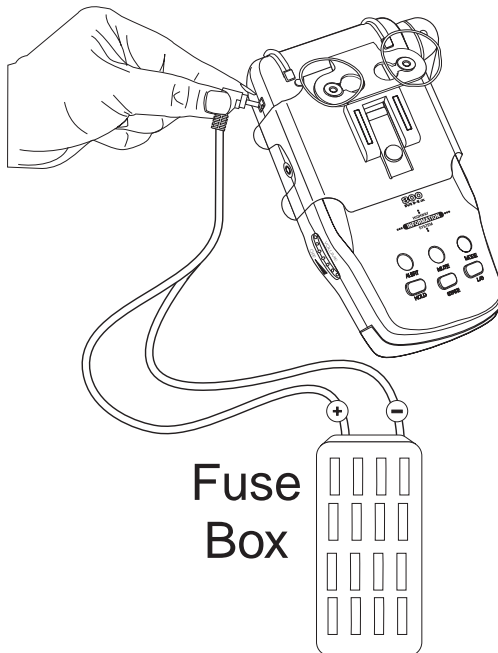

3. Run the power cord from the fuse box to the BCT-12.

Note: *Ensure the cord does not interfere with vehicle operation or cause a tripping hazard.*

4. Plug the power cord connector into the BCT-12 at the jack labeled "DC 12V."

Note: *Push the connector firmly into the jack.*

Using the Cigarette Lighter Adapter

1. Insert the small connector into the jack on the side of the unit.

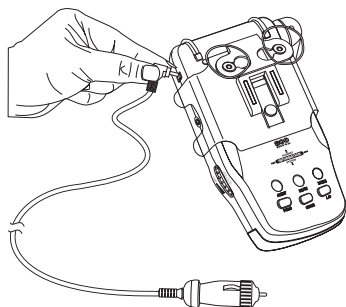

2. Insert the other end into the cigarette lighter socket of your vehicle.

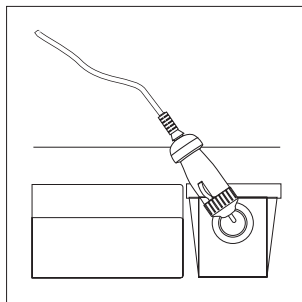

When installing the power cord, make sure that:

- The socket is clean to allow proper contact.
- The power cord does not block the antenna area of the unit.

Your unit also comes with 10 power cord mounting clips. You can use these clips to attach the power cord to the window frame or other parts of the vehicle, keeping it neat and out of the way. Use the double-sided foam tape squares to attach each clip. Slip the power cord into the clip to hold it securely in place.

Replacing the Fuse

The cigarette lighter plug contains a 1-ampere fuse to protect it from power surges.

1. To replace the fuse, unscrew the top of the plug.
2. Remove the fuse and replace it with the same type.
3. To replace the top, push in the two metal contacts and twist into place.

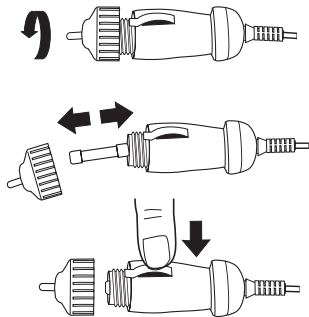

Operating Instructions

Applying Power

1. Turn the OFF/VOLUME control counterclockwise to power on the scanner. Adjust the volume about 1/4 turn.

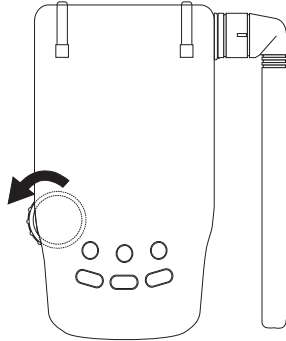

2. During power-on, a self-test is performed. Check the front control panel for proper operation.
3. All the LED's on the front control panel light up and the numbers 1 through 9 count up on the LED display. An Alert tone is also sounded. This tells you that the scanner is working properly.



4. The currently selected state appears on the display. The BCT-12 always comes on with the last settings selected and in the last mode of operation.



Adjusting the Squelch

Think of the Squelch Control as a gate.

1. Turn the SQUELCH control fully counterclockwise. This raises the “Squelch Gate” so high that no signals can get through.

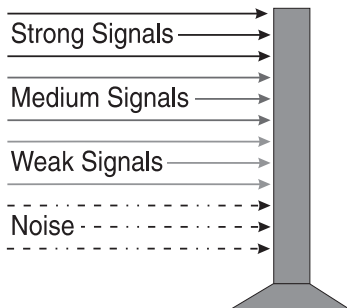
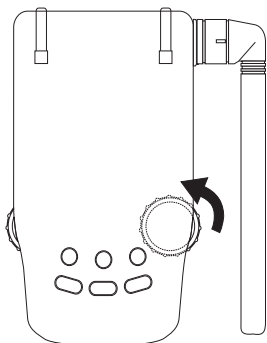

2. Turn the SQUELCH control fully clockwise until you hear a hiss. This lowers the “Squelch Gate” so that everything gets through ... noise, weak signals, and strong signals.

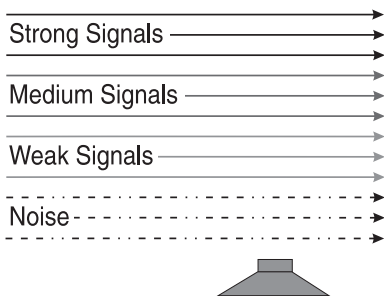
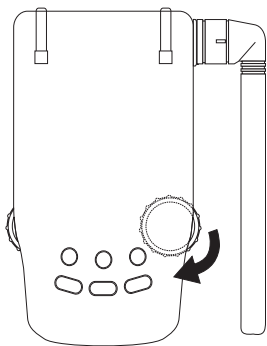

3. Turn the SQUELCH control back counter clockwise just until the hiss stops. Now the “Squelch Gate” allows only strong signals through.

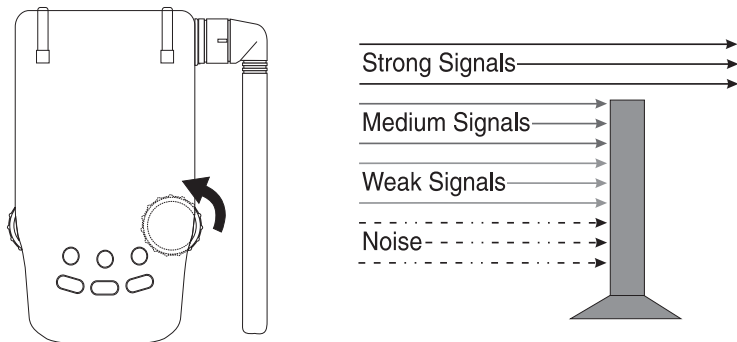

4. Sometimes when you open the Squelch, you may trigger the Alert feature even though no highway patrol cars are in the area. If this happens, turn the SQUELCH control counterclockwise until the “rushing” noise stops. Then turn the BCT-12 off, and back on, to reset the Alert feature.

Note: *In metropolitan areas, you may want to adjust the Squelch control more counterclockwise to reduce the range of the Alert feature. When set fully counterclockwise, Squelch limits the Alert range to a short distance.*

Selecting the State

See the foldout inside the front cover or your Quick Reference Guide for key positions.

1. Select the state you are operating in by pressing the **STATE** key repeatedly. If you press and hold the **STATE** key for 2 seconds, the selector moves rapidly through all the states and Canadian provinces.
2. The state code appears on the display. See the following page for a list of state codes and Canadian provinces.



Note: *The state codes are in alphabetical order by abbreviation, followed by the Canadian province codes.*

State and Canadian Province Codes

Code	State	Code	State
AK	Alaska	NM	New Mexico
AL	Alabama	NV	Nevada
AR	Arkansas	NY	New York
AZ	Arizona	OH	Ohio
CA	California	OK	Oklahoma
CO	Colorado	OR	Oregon
CT	Connecticut	PA	Pennsylvania
DC	District of Columbia	RI	Rhode Island
DE	Delaware	SC	South Carolina
FL	Florida	SD	South Dakota
GA	Georgia	TN	Tennessee
HI	Hawaii	TX	Texas
IA	Iowa	UT	Utah
ID	Idaho	VA	Virginia
IL	Illinois	VT	Vermont
IN	Indiana	WA	Washington
KS	Kansas	WI	Wisconsin
KY	Kentucky	WV	West Virginia
LA	Louisiana	WY	Wyoming
MA	Massachusetts	AB	Alberta
MD	Maryland	BC	British Columbia
ME	Maine	MB	Manitoba
MI	Michigan	NB	New Brunswick
MN	Minnesota	NF	Newfoundland
MO	Missouri	NS	Nova Scotia
MS	Mississippi	NT	Northwest Territories
MT	Montana	ON	Ontario
NC	North Carolina	PE	Prince Edward Island
ND	North Dakota	PQ	Quebec
NE	Nebraska	SK	Saskatchewan
NH	New Hampshire	YT	Yukon Territories
NJ	New Jersey	XX	All Frequencies

Selecting the Frequencies to Scan

Once you have selected the State or Canadian province, you are ready to select the frequencies you want to scan.

Scanning Highway Patrol Frequencies

This mode scans State Police/Highway Patrol frequencies by state. Mobile extender and other enforcement channels are priority checked for activity.

Note: *The priority check can be turned off by pressing and holding the Alert key for 1.5 seconds.*

1. To scan highway patrol frequencies exclusively, press the  key repeatedly until HP is blinking in the LED display.



2. The HP LED lights up.



3. While scanning, the BCT-12 displays the state code for the state you selected. When the BCT-12 detects an active frequency, it displays HP in the LED display and stops for two seconds before it resumes scanning.

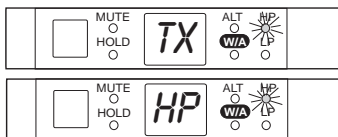

Scanning Local Police Frequencies

This mode scans only the local police and county sheriff frequencies. Mobile extenders and other enforcement channels of the Highway Patrol are priority checked for alarm activity.

Note: *The priority check can be turned off by pressing and holding the Alert key for two seconds.*

- To scan local police frequencies, press the  key repeatedly until LP is blinking in the LED display.



- The LP LED will light up.



- While scanning, the BCT-12 displays the state code for the state you selected. When the BCT-12 detects an active frequency, it displays LP in the LED display. The BCT-12 will stop for two seconds, and then resume scanning with the state code displayed in the LED display.

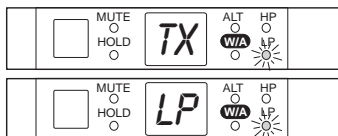

Scanning All Police Frequencies

This mode scans standard State Police/Highway Patrol frequencies as well as local police and county sheriff frequencies. Mobile extenders and other enforcement channels of the Highway Patrol are priority checked for alarm activity.

Note: *The priority check can be turned off by pressing and holding the Alert key for 1.5 seconds.*

1. To scan highway patrol and local police frequencies, press the  key repeatedly until HL is blinking on the LED display.



2. The LP and HP LED's will light up.



3. While scanning, the BCT-12 displays the state code for the state you selected. When the BCT-12 detects an active frequency, it displays either LP for local police or HP for highway patrol in the LED display. The BCT-12 will stop for two seconds, and then resume scanning with the state code displayed in the LED display.



Scanning News Media Frequencies

This mode scans radio conversations from traffic reporters, news reporters, and photographers as they report the slowdowns and tie-ups on area roads and chase down the news stories of the day. The news mode also scans the GMRS (General Mobile Radio Service) frequencies for "Notification Net" radio traffic.

Note: *Priority Alert does not work in this mode.*

1. To scan news media frequencies, press the  key repeatedly until NW is blinking in the LED display.



- When the BCT-12 detects an active frequency, it displays NW in the LED display. The BCT-12 will stop for two seconds, and then resume scanning with NW blinking in the LED display.



Scanning Department of Transportation Frequencies

This mode scans the state road repair, snow clearing, and weigh station crews of the state's Department of Transportation as well as Highway Patrol channels. This mode is outstanding for driving during hazardous or winter weather. Mobile extender and other enforcement channels are priority checked for activity.

Note: The priority check can be turned off by pressing and holding the Alert key for 1.5 seconds.

- To scan DOT frequencies, press the **MODE** key repeatedly until DT is blinking on the LED display.



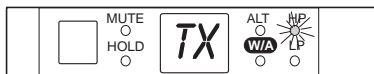

- While scanning, the BCT-12 displays the state code for the state you selected. When the BCT-12 detects an active frequency, it displays DT or HP in the LED display. The BCT-12 will stop for two seconds, and then resume scanning with the state code displayed in the LED display.



Scanning All Frequencies

Note: The Weather Alert and Priority Alert features are not active in this mode.

1. To scan all frequencies (except Weather), press the  key repeatedly or press and hold the  key until "XX" is blinking on the LED display.



2. All frequencies, except weather channels, are scanned for an active transmission.

3. When the BCT-12 finds an active frequency, it activates a built-in two second delay before it resumes scanning.



Note: The  key does not operate while XX is selected.

Priority Alert

In most cases, when you are within three miles of a priority checked channel (see Priority Alert on page 2) your BCT-12 will set off a visual and audible alarm. The signal strength will be displayed, and the LED display will return to HP. The time the ALARM LED will stay on depends on the signal strength.

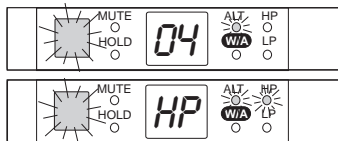

Turning Priority Alert On/Off

To turn priority alert off while in HP, LP, HL, or DOT Mode:

Press and Hold the  key for 1.5 seconds. A confirmation beep sounds and the ALT LED goes off.



To turn priority alert on while in HP, LP, HL, or DOT Mode:

Press and Hold the  key for 1.5 seconds. A confirmation beep sounds and the ALT LED goes on.



Setting the Highway Patrol Alarm Volume

You can set the Alert Tone volume to either Low, Medium, or High. To change the Alert Tone volume:

Press the  Key. You hear a beep and L (low), M (medium), or H (high) is displayed in the LED display.



Muting the Priority Alert

While in the highway patrol mode you can turn off the alarm tone during the time you are listening to a frequency or disable the alarm tone permanently. To disable the alarm tone while listening to a frequency:

1. While in the highway patrol mode and after you receive an alarm tone, press the  key. The MUTE LED flashes.



Note: Only the alarm tone will be disabled. You will still receive highway patrol and weather alert alarms, but only the ALARM LED will come on.

2. To enable the Alert Tone again, press the  key again.

Note: When the ALARM LED goes off, the mute mode will no longer be on.

To disable the alarm tone permanently:

Press and Hold the  key for 1.5 seconds. You hear two beeps and the MUTE LED comes on.



Note: When the MUTE LED is on and not flashing, you can receive highway patrol alarms, but the alarm tone does not sound. Turning the BCT-12 off and back on will turn the alarm back on.

Monitoring Weather Frequencies

1. To monitor weather frequencies, press the  key repeatedly until WX is blinking on the LED display.



2. While scanning, the BCT-12 will display WX in the LED display. When the BCT-12 detects an active frequency, it displays the weather channel in the LED display and stops scanning.

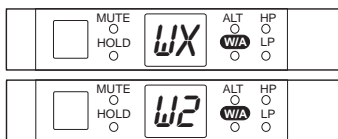

3. Press the **(L/O)** key to make the BCT-12 scan for the next weather frequency.

Weather Alert

The Weather Alert feature can be set to operate along with the HP, HL, LP, or WX modes. An alert tone is sounded when an emergency weather bulletin is broadcast. In WX mode, there is no audio until an emergency weather bulletin is broadcast.

Turning Weather Alert On/Off

To turn on Weather Alert:

Put the BCT-12 in WX mode and press and release the **(ALT)** Key. A confirmation beep sounds and the ALT LED goes on.

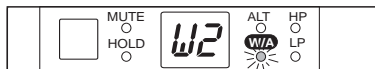

Note: You can switch back to HP, LP, or HL modes and the Weather Alert mode will remain on.

To turn off Weather Alert

Put the BCT-12 in WX mode and press the **(ALT)** Key. A confirmation beep sounds and the ALT LED goes off.

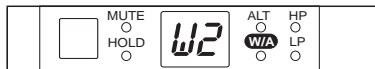

Deleting Frequencies

Some frequencies that have been pre-programmed into your BCT-12 may not be of immediate interest to you, may be experiencing interference, or are being used as data channels. You can lock out those frequencies from scanning.

When the scanner stops on the undesired frequency, press  one time. To lock out additional frequencies, repeat this step.

Note: *You can delete a maximum of 50 frequencies. Although it is possible to delete the highway patrol alarm frequencies, this should never be done unless absolutely necessary for proper operation of your BCT-12. This causes the highway patrol alarm feature to be inactive on that frequency. No further alarms will be received until the deleted frequencies are restored or a new state is selected. A frequency deleted in one state will not be deleted in any other states. The deleted frequencies are maintained in memory even when your BCT-12 is turned off.*

Caution: *When you lock out more than 50 frequencies, the first locked out frequency is deleted. You cannot lock out all of the alarm, local police, and highway patrol frequencies. If you lock out all of the frequencies by accident, the BCT-12 will sound two short beeps.*

Restoring Deleted Frequencies

Please note that you can only restore all deleted frequencies at the same time.

To restore the deleted frequencies:

1. Make sure the BCT-12 is not scanning. To stop the unit from scanning, turn the SQUELCH knob toward the front of the BCT-12.

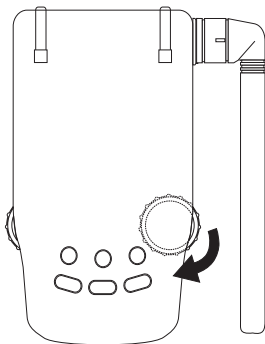

2. Press and hold the  key until you hear two beeps. All deleted frequencies are now restored.

Using HOLD to Stay on a Selected Frequency

When scanning stops on a desired frequency, you can lock onto that frequency for as long as you like.

To monitor only one frequency:

1. When the scanner stops on the desired frequency, press the **HOLD** key. The LED display now indicates the mode you are monitoring. The scanner remains on that frequency until you cancel the Hold mode by pressing **HOLD**.

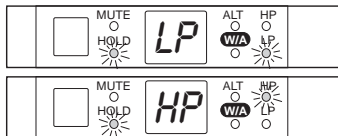

2. To resume scanning and reactivate the Alert feature, press the **HOLD** key.

If the BCT-12 stops on an undesired frequency, press the **HOLD** key twice to force the unit to start scanning again before the end of that transmission.



BE CAREFUL!! When you are in the Hold mode, there will be no Alert tones or Warning light, even if you are on the Alert frequency.

REMEMBER!! When you apply power, the BCT-12 comes on to exactly the same service and in exactly the same mode as when last turned off. If you are monitoring an Alert frequency in the Hold mode when you turn the BCT-12 off, it will come back to that Alert frequency in Hold mode when you turn it back on. The Alert feature will be inactive. To restore the Alert feature, press the **HOLD** key.

Memory Backup

Your BCT-12 has a memory backup system that remembers your frequency selections and deletions when you turn off the unit. This memory lasts permanently without any external power to the unit.

Birdies

There may be situations where your BCT-12 emits strange sounds through its speaker. This should be a temporary situation that will change as you drive. If the situation does not change, no matter what your location, you may consider locking out these channels with the  key. If your scanner stops during Scan mode and no sound is heard, press the  key twice to resume scanning.

Important Operating Tips

Your BCT-12 is not a radar detector. Using a Uniden radar detector in tandem with your BCT-12 will provide you with an excellent form of protection on the interstates. The best way to use your BCT-12 is to rely both on the warning tones as well as on the regular voice communications heard on the scanner.

The alarm circuit on your BCT-12 provides you with a degree of protection that varies from state to state. Not all states employ mobile extenders, but all states do have frequencies that have been flagged for use by special enforcement teams.

Remember, the warning circuit only works with State Police and Highway Patrol cars, not with local police. For local police and county sheriff information, you must listen to the scanner audio to monitor local police radio traffic.

Troubleshooting

If your BCT-12 is not performing properly, try the steps listed below.

PROBLEM	POSSIBLE SOLUTION
Scanner is not working properly.	Check power cord and in-line fuse. Check the Volume and Squelch settings.
Signal is weak or distorted.	Check antenna and antenna connection, or change antenna.*
Improper reception.	Check antenna and antenna connection, or change antenna.* Reposition scanner.
Scan won't stop.	Check Squelch adjustment. Check antenna and antenna connection, or change antenna.*
Incomplete reception.	Fringe area of reception. Check Squelch adjustment.
Weather Search (WX) won't work.	Check Squelch adjustment. No active station within range.

* Also see "Helpful Tips" on page 5.

If you still cannot get satisfactory results and you wish to receive product information or return the unit for service, please call or write the Uniden Parts and Service Division at:

Uniden America Corporation
4700 Amon Carter Blvd.
Fort Worth, TX 76155
(800) 297-1023 Monday through Friday,
8:00 a.m. to 5:00 p.m. Central

Optional Accessories

The following optional accessories for your BCT-12 are available from your local Uniden Dealer or through the Uniden Customer Service Center by calling: (800) 297-1023, 8:00 a.m. to 5:00 p.m. Central, Monday through Friday.

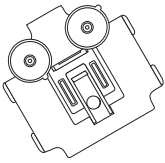

Windshield Mounting
Bracket and Hardware

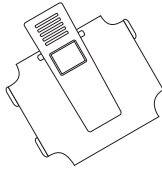

Visor Clip Mounting
Bracket



BCT-12 Antenna

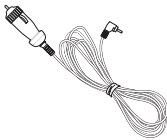

Cigarette Adapter Power
Cord

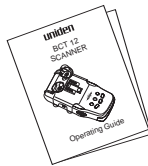

BCT-12 Operating Guide

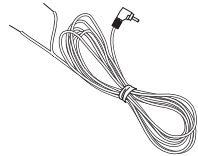

Straight Power Cord



External Speaker



Coiled Cigarette Adapter

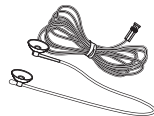

Window Mount Antenna

Specifications

Size:	76W X 136.5D X 33H
Weight:	180 g
Power:	13.8 VDC
Operating Temperature:	-20° C (-4° F) to +60° C (+140° F)
Antenna:	50Ω impedance
RF Sensitivity: (FM 12dB signal to noise ratio at 3kHz deviation)	37.02 - 46.02 MHz 0.3μV 138.3450 - 172.0200 MHz 0.4μV 423.0000 - 508.4875 MHz 0.5μV
Frequency Coverage:	VHF Low Band 37.02 - 46.02 MHz VHF High Band 138.3450 - 172.0200 MHz UHF Band 423.0000 - 508.4875 MHz 806.0125 - 868.9875 MHz
Audio Output:	Max 1W

Certified in accordance with FCC Rules and Regulations Part 15 as of date of manufacture.

Specifications are typical and subject to change without notice.

Color profile: Disabled
Composite Default screen

G:...Bct12 pdf.vp
Wed Dec 03 11:27:46 1997

Precautions

Before you use this scanner, please observe the following:

WARNING!

Uniden America Corporation does not represent this unit to be waterproof. To reduce the risk of fire, electrical shock, or damage to the unit, do not expose this unit to rain or moisture.

IMPORTANT!

The installation, possession, or use of this scanning radio in a motor vehicle may be prohibited, regulated, or require a permit in certain states, cities, and/or local jurisdiction. Your local law enforcement officials should be able to provide you with information regarding the laws in your community.

Controls and Indicators

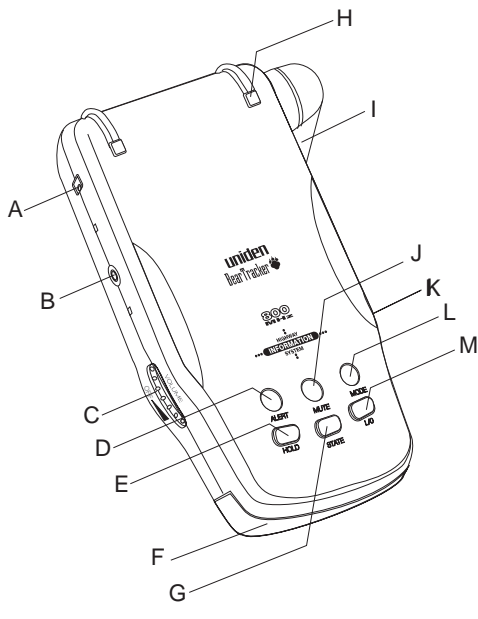

- A. DC Input
- B. External Speaker Out
- C. On/Off Volume
- D. ALERT Key (ALT)
- E. HOLD Key (HOLD)
- F. Control Panel
- G. STATE Key (STATE)
- H. Windshield Bumpers
- I. Antenna
- J. MUTE Key (MUTE)
- K. Squelch Control
- L. MODE Key (MODE)
- M. L/O (Lock Out) Key (L/O)

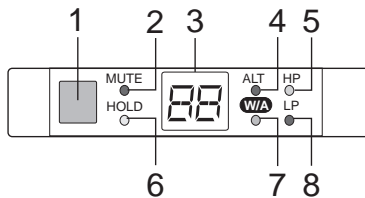

- 1. ALARM LED
- 2. MUTE LED
- 3. 2-Digit LED Display
- 4. Alert Mode LED
- 5. Highway Patrol LED
- 6. HOLD LED
- 7. Weather Alert LED
- 8. Local Police LED

CONTENTS

Introduction	1
Welcome.....	1
Features	1
Terms and Definitions.....	2
Unpacking.....	3
Included with Your BCT-12 Scanner	4
Installation.....	5
Helpful Tips.....	5
Optional Antennas	5
Installing the Antenna.....	6
Mounting the BCT-12	7
Connecting the Power	12
Direct Connection.....	12
Using the Cigarette Lighter Adapter	13
Replacing the Fuse.....	14
Operating Instructions.....	15
Applying Power.....	15
Adjusting the Squelch.....	16
Selecting the State	18
State and Canadian Province Codes	19
Selecting the Frequencies to Scan.....	20
Priority Alert.....	24
Weather Alert.....	27
Deleting Frequencies.....	28
Restoring Deleted Frequencies	29
Using HOLD to Stay on a Selected Frequency	30
Memory Backup.....	31
Birdies.....	31
Important Operating Tips.....	31
Troubleshooting	32
Optional Accessories	33
Specifications.....	34

One Year Limited Warranty

Important: Evidence of original purchase is required for warranty service.

WARRANTOR: UNIDEN AMERICA CORPORATION (“Uniden”)

ELEMENTS OF WARRANTY: Uniden warrants, for one year, to the original retail owner, this Uniden Product to be free from defects in materials and craftsmanship with only the limitations or exclusions set out below.

WARRANTY DURATION: This warranty to the original user shall terminate and be of no further effect 12 months after the date of original retail sale. The warranty is invalid if the Product is (A) damaged or not maintained as reasonable or necessary, (B) modified, altered, or used as part of any conversion kits, subassemblies, or any configurations not sold by Uniden, (C) improperly installed, (D) serviced or repaired by someone other than an authorized Uniden service center for a defect or malfunction covered by this warranty, (E) used in any conjunction with equipment or parts or as part of any system not manufactured by Uniden, or (F) installed or programmed by anyone other than as detailed by the Operating Guide for this product.

STATEMENT OF REMEDY: In the event that the product does not conform to this warranty at any time while this warranty is in effect, warrantor will repair the defect and return it to you without charge for parts, service, or any other cost (except shipping and handling) incurred by warrantor or its representatives in connection with the performance of this warranty. THE LIMITED WARRANTY SET FORTH ABOVE IS THE SOLE AND ENTIRE WARRANTY PERTAINING TO THE PRODUCT AND IS IN LIEU OF AND EXCLUDES ALL OTHER WARRANTIES OF ANY NATURE WHATSOEVER, WHETHER EXPRESS, IMPLIED OR ARISING BY OPERATION OF LAW, INCLUDING, BUT NOT LIMITED TO ANY IMPLIED WARRANTIES OF MERCHANTABILITY OR FITNESS FOR A PARTICULAR PURPOSE. THIS WARRANTY DOES NOT COVER OR PROVIDE FOR THE REIMBURSEMENT OR PAYMENT OF INCIDENTAL OR CONSEQUENTIAL DAMAGES. Some states do not allow this exclusion or limitation of incidental or consequential damages so the above limitation or exclusion may not apply to you.

LEGAL REMEDIES: This warranty gives you specific legal rights, and you may also have other rights which vary from state to state. This warranty is void outside the United States of America.

PROCEDURE FOR OBTAINING PERFORMANCE OF WARRANTY: If, after following the instructions in this Operating Guide you are certain that the Product is defective, pack the Product carefully (preferably in its original packaging). Include evidence of original purchase and a note describing the defect that has caused you to return it. The Product should be shipped freight prepaid by traceable means, or delivered, to warrantor at:

Uniden America Corporation
Parts and Service
4700 Amon Carter Blvd.
Fort Worth, TX 76155

(800) 297-1023, 8:00 a.m. to 5:00 p.m. Central, Monday through Friday

PAT. UNDER ONE OR MORE OF THE FOLLOWING
U.S. PATENT NUMBERS:

3,883,808, 3,961,261, 3,962,644, 3,974,450
3,974,452, 3,987,400, 3,996,521, 3,996,522
4,000,468, 4,027,251, 4,057,760, 4,092,594
4,100,497, 4,114,103, 4,123,715, 4,153,877
4,156,193, 4,157,505, 4,179,662, 4,219,821
4,270,217, 4,398,304, 4,409,688, 4,455,679
4,461,036, 4,521,915, 4,627,100, 4,888,815
4,932,074, 4,947,456, 5,014,348, DES 253,173
DES 272,737, RE 31,523

©1996 Uniden America Corporation. All rights reserved.